

Conklin

CONKLIN DEALER BROCHURES, 1937
KINDLY PROVIDED BY MR. FRED KRINKE

V-LINE • NEW • ATTRACTIVE PENS & PENCILS

All instruments illustrated here in actual size are available in any of the rich new colors shown at the right, and are characterized by all the famous Conklin Nozac (no sac) features — revolutionary Cushion Point that writes with advanced ease and smoothness from the moment it touches paper; dependable patented self-filler that "winds like a watch"; extra large ink capacity; visible ink chamber; leakless inner cap
The Conklin Pen Company, Toledo, Ohio.

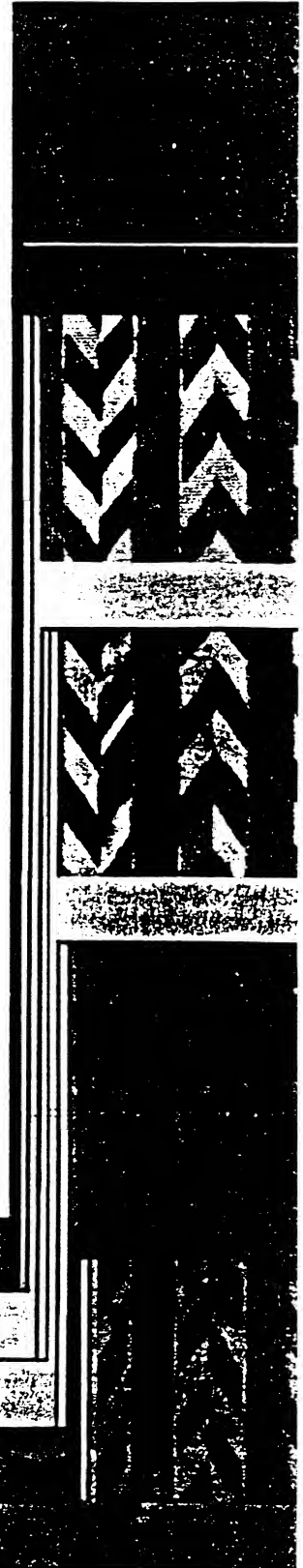
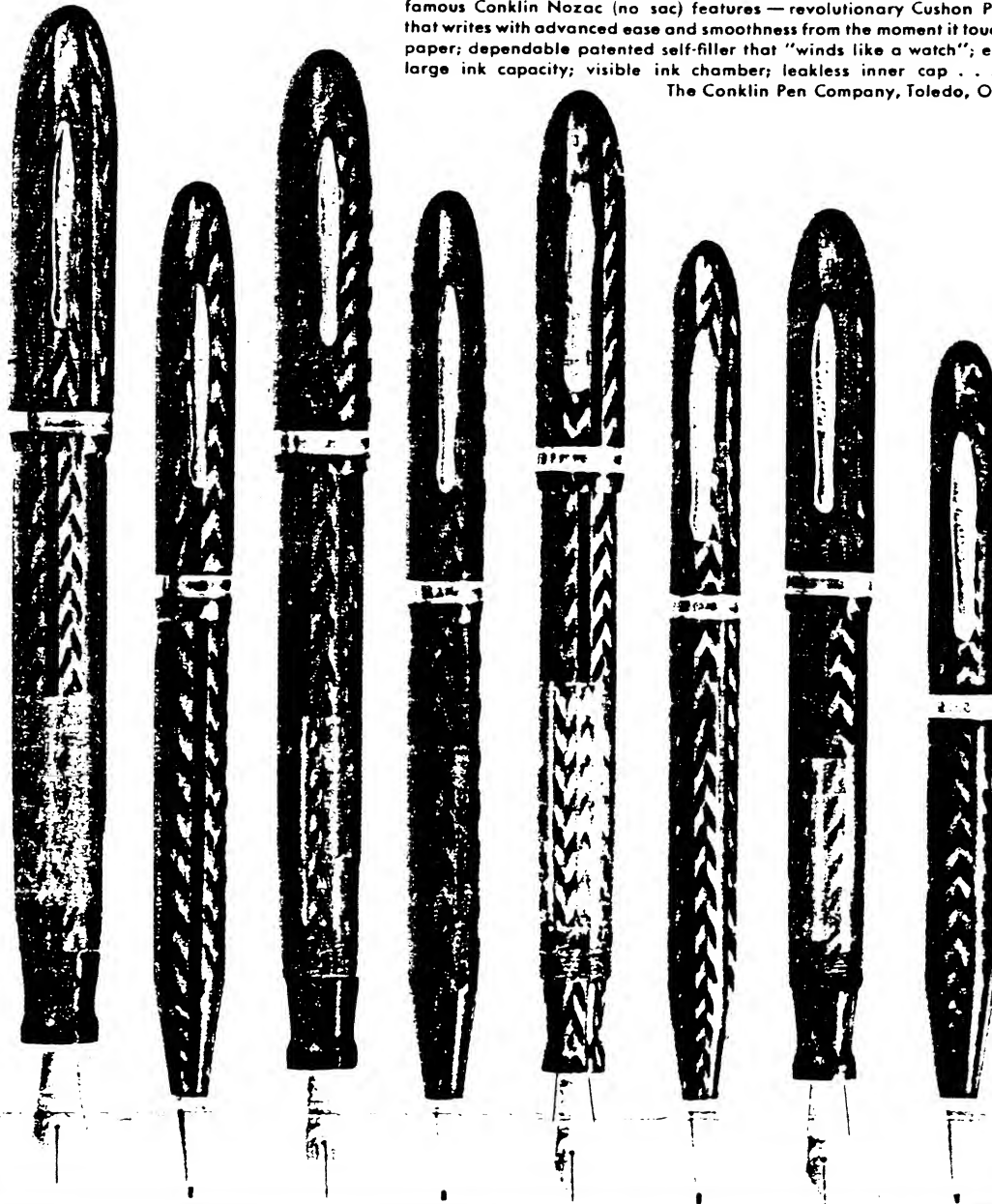

BLACK	DVN 58	DP 4	DVN 47	DP 4	CVNX 36	CPX 4	CVNX 36 S	CPX 4 S
GREY	DVN 58 P	DVP 4 P	DVN 47 P	DP 4 P	CVNX 36 P	CVPX 4 P	CVNX 36 PS	CVPX 4 PS
RED	DVN 58 R	DVP 4 R	DVN 47 R	DP 4 R	CVNX 36 R	CVPX 4 R	CVNX 36 RS	CVPX 4 RS
GREEN								
BLUE								
PRICE	\$7.50	\$3.50	\$5.00	\$3.50	\$5.00	\$3.50	\$5.00	\$3.50

Above pens and pencils also available in beautifully packaged sets from \$8.50 to \$11.00. When ordering sets, prefix the letter Y to the regular number of the pen.

Nibs: Conklin Cushion Point in extra fine, fine, medium, coarse, stub medium, stub broad, left oblique, two way; Recorder in extra fine, fine, medium. 14 karat solid gold.

Conklin PENLINE • NEW • ATTRACTIVE PENS & PENCILS

Like the V-Line, the new Conklin Penline is available in beautiful new colors which reflect the current trend toward quality and dignity and express the matchless excellence of Conklin Nozac instruments. All pens and pencils illustrated in actual size on this page in any of the colors shown at the right.

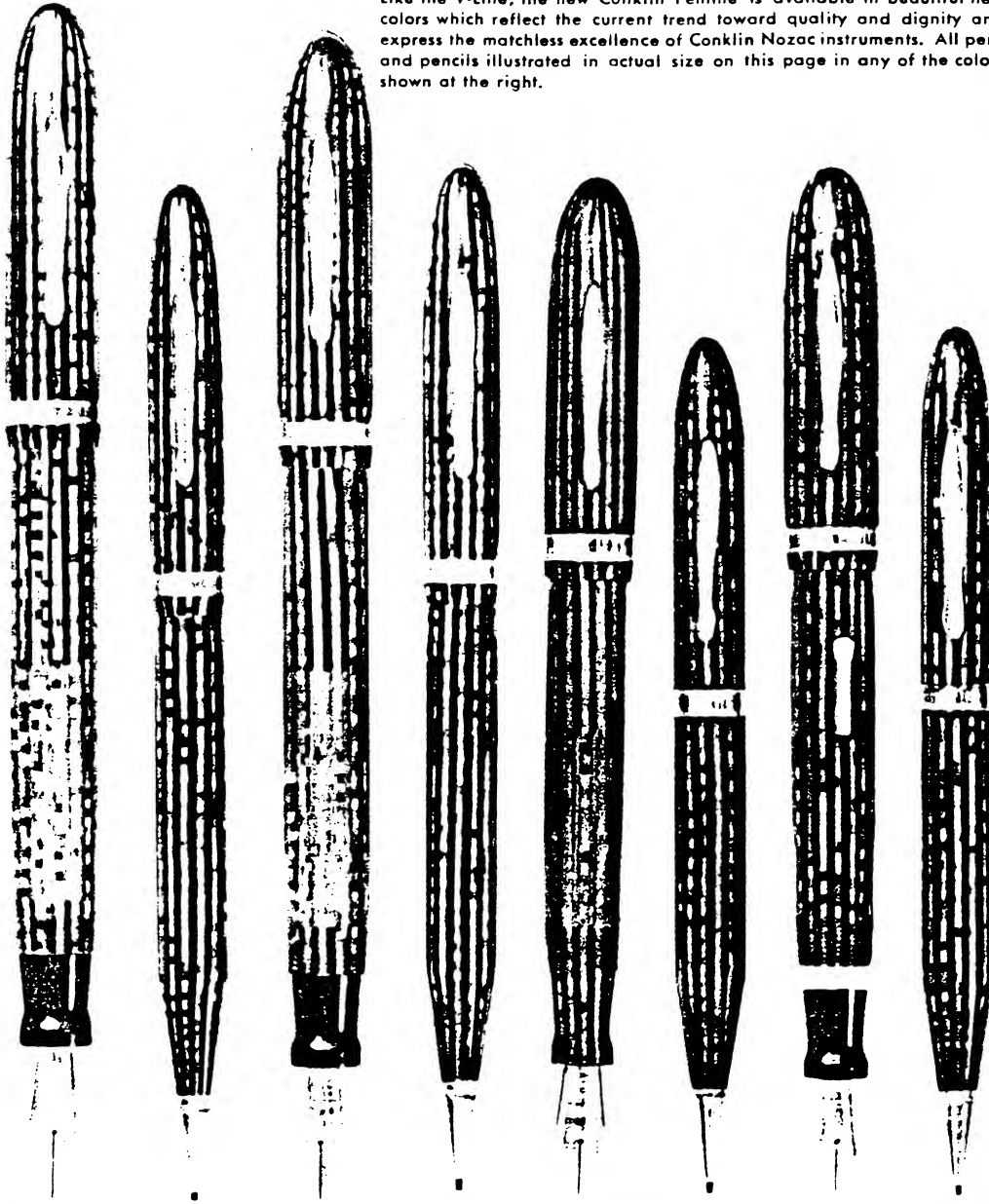

				DVNX-36 S.	DPPX 4 S.	DPS-36 S.	DP 4 S.
DPN 58 P	DPP 4 P	DPN 47 P	DPP 4 P	DPNX 36 PS	DPPX 4 PS	DPS 36 PS	DPP 4 PS
DPN 58 R	DPP 4 R	DPN 47 R	DPP 4 R	DPNX 36 RS	DPPX 4 RS	DPS 36 RS	DPP 4 RS
DPN 58 A	DPP 4 A	DPN 47 A	DPP 4 A	DPNX 36 AS	DPPX 4 AS	DPS 36 AS	DPP 4 AS
\$7.50	\$3.50	\$5.00	\$3.50	\$7.50	\$5.00	\$5.00 Sac-type	\$3.50

Above pens and pencils available in sets from \$8.50 to \$12.50; packaged in beautiful, specially designed boxes. To order sets, prefix pen number with the letter Y.

Nibs: Conklin Cushion Point in extra fine, fine, medium, coarse, stub medium, stub broad, left oblique, two way; Recorder in extra fine, fine, medium. 14 karat solid gold.

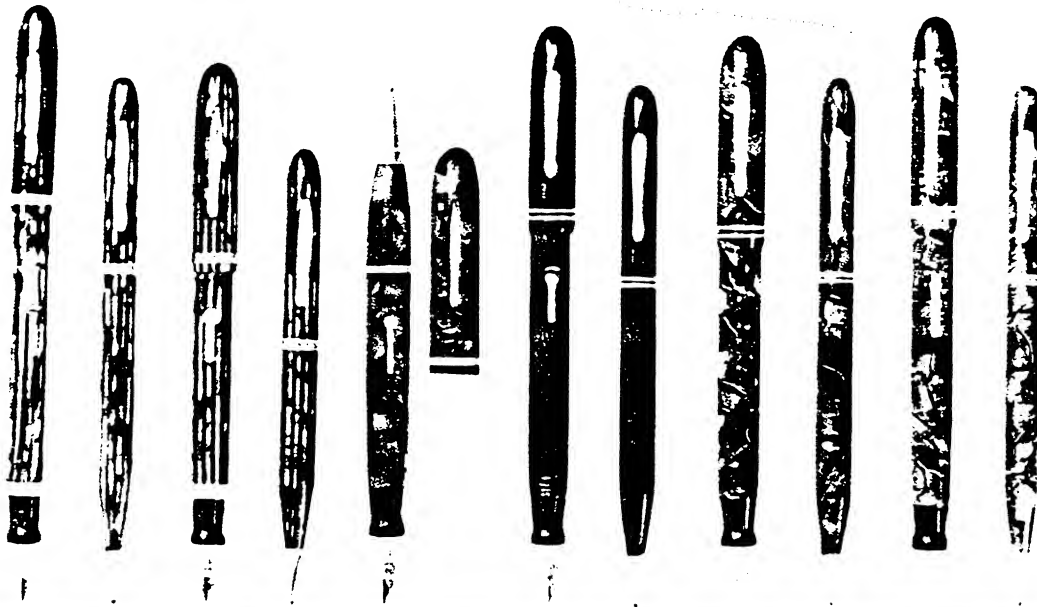

Conklin GENERAL LINE

The Conklin General Line includes, as illustrated $\frac{1}{2}$ actual size, from left to right, ladies' sac pens and pencils in long and short lengths, Ensembles, standard Conklin sac pen and pencil, All American vacuum pens and pencils, All American sac pens and pencils. For those who prefer inexpensive instruments, Conklins offer the maximum in performance and style.

BLACK	CS 36 S	CP 4 P	CS 36 S	CP 4 S	CE 47	26 C	63		64	63	
GREY	CLS 36 P	CLP 4 P	CLS 36 PS	CLP 4 PS				P 295 RP	63 RP	64 RP	63 RP
RED	CLS 36 R	CLP 4 R	CLS 36 RS	CLP 4 RS				P 295 RG	63 RG	64 RG	63 RG
GREEN											
PRICE	\$3.50	\$2.50	\$3.50	\$2.50	\$5.00	\$2.75	\$1.00	\$2.95	\$1.00	\$1.95	\$1.00



PEN AND PENCIL SETS

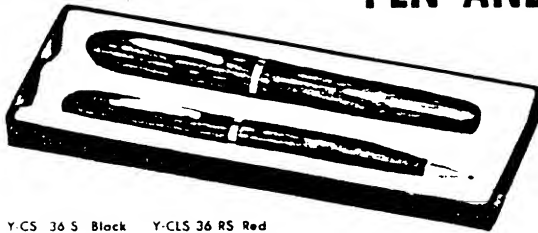

Y-CS 36 S Black Y-CLS 36 RS Red
Y-CLS 36 PS Grey Y-CLS 36 GS Green
Ladies' Penline sac-type; short length.
\$6.00 retail value specially priced when
sold as set only. Set, \$5.00.

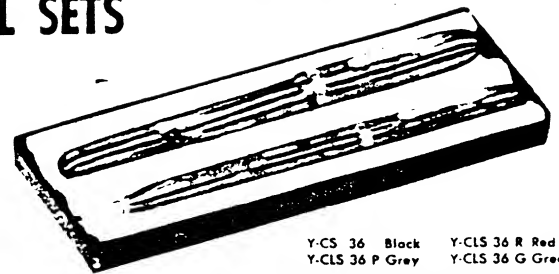

Y-CS 36 Black Y-CLS 36 R Red
Y-CLS 36 P Grey Y-CLS 36 G Green
Ladies' Penline sac-type; long length.
\$6.00 retail value specially priced when
sold as set only. Set, \$5.00.

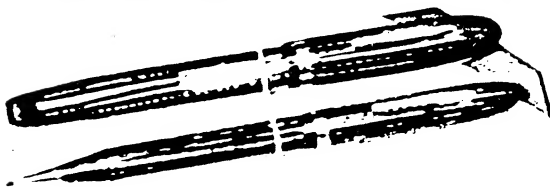

Y-DPN 47 P Grey Y-DPN 47 G Green
Y-DPN 47 R Red Y-DPN 37 A Golden
Penline Nozoc; medium size. Set, \$8.50.

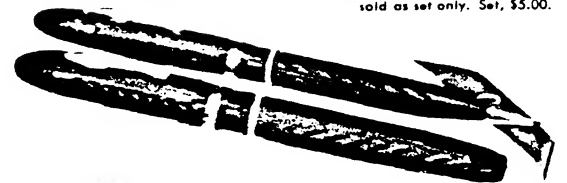

Y-DVN 47 Black Y-DVN 47 R Red
Y-DVN 47 P Grey Y-DVN 47 G Green
Y-DVN 47 B Blue
V-Line; medium size. Set, \$8.50.

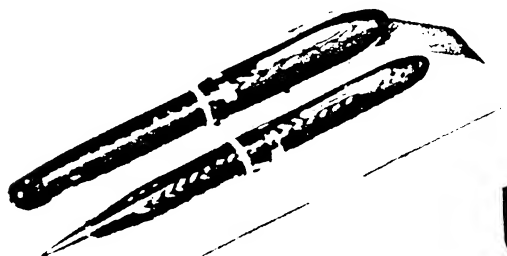

Y-CVNX 36 S Black Y-CVNX 36 RS Red
Y-CVNX 36 PS Grey Y-CVNX 36 GS Green
Y-CVNX 36 BS Blue
Ladies' V-Line; short length. Set, \$8.50.

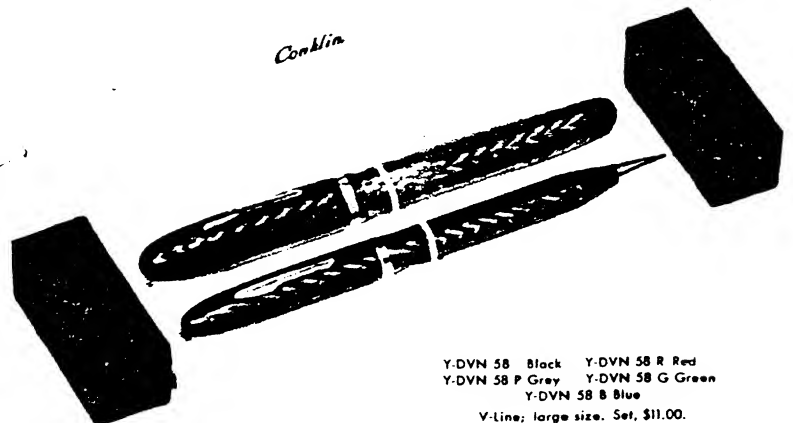

Y-DVN 58 Black Y-DVN 58 R Red
Y-DVN 58 P Grey Y-DVN 58 G Green
Y-DVN 58 B Blue
V-Line; large size. Set, \$11.00.

Conklin

CUSTOM PEN AND PENCIL SETS

Conklin Custom Pens have hand-ground nibs for which grinders are paid a special premium to insure finest workmanship. These extra fine pen and pencil sets are distinctively packaged in handsome gift boxes.

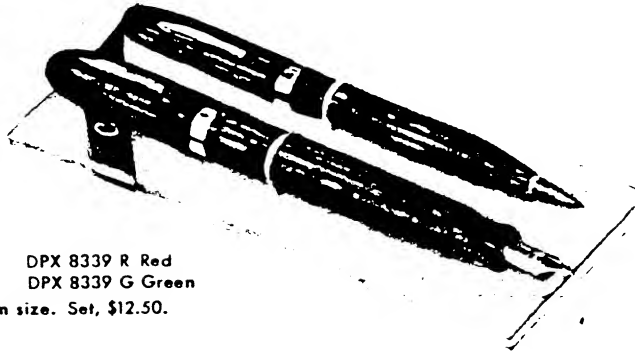
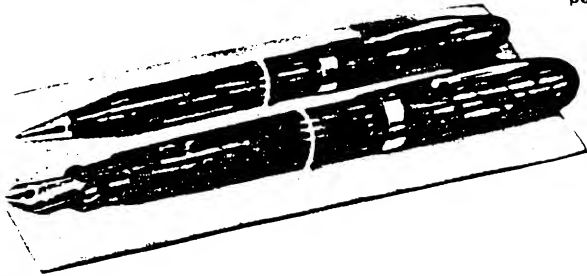

DCX 8359 Black DPX 8359 R Red
 DPX 8359 P Grey DPX 8359 G Green
 Penline; large size. Set, \$15.00.

DCX 8339 Black DPX 8339 R Red
 DPX 8339 P Grey DPX 8339 G Green
 Penline; medium size. Set, \$12.50.

DESK SETS

Conklin Desk Sets are noted for their combined beauty and service. Bases are made of only the finest materials—in colors that blend harmoniously with Conklin Desk Pens—in styles to suit any type of desk. Any of the following \$5.00 desk pens available for these bases: Penline—DL 19 G, Green; DL 19 R, Red; DL 19 P, Pearl. Chevron—DC 19 R, Red. V-Line—DVNT 47 G, Nile Green; DVNT 47 B, Royal Blue; DVNT 47 R, Burgundy Red; DVNT 47 P, Pearl Grey; DVNT 47, Black.

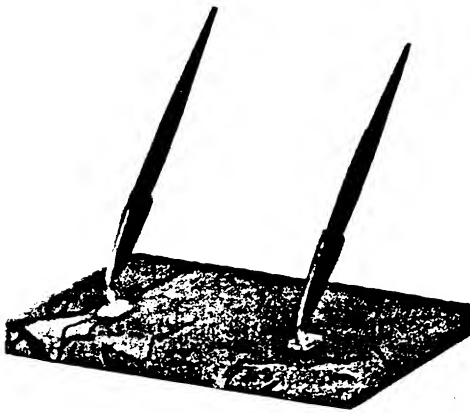

219 Brazilian Onyx
 Size—10" x 5 3/4" x 3/4"
 Base only, \$27.50
 Pens extra

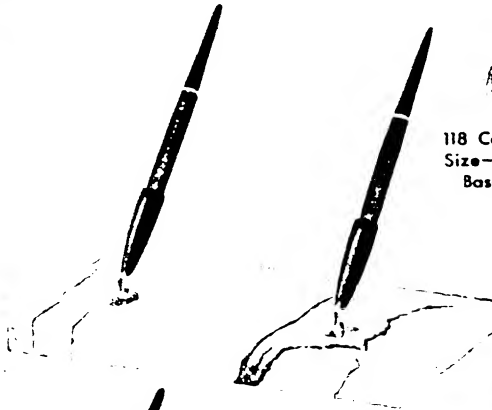

218 California Onyx
 216 Black Crystal
 2110 Marble
 Size—10" x 5 3/4" x 3/8"
 Base only, \$17.50
 Pens Extra



118 California Onyx
 Size—3 1/2" Diameter
 Base only, \$5.00
 Pen extra



211 Black Crystal
 213 California Onyx
 214 Italian Marble
 Size—3 3/4" x 7" x 3/4"
 Base only, \$10.00
 Pens Extra



313 Burwood
 Size—4 3/4" x 7 3/8". Complete with
 Black pen, \$4.95



2115 Italian Marble
 2111 Black Crystal
 Size—8" x 13" x 1"
 Base only, \$27.50
 Pens Extra



114 Marble—111 Black Crystal—113 Onyx
 Sizes—2 3/4" x 3 3/4" x 1/2"
 Base only, \$5.00. Pen extra.



NOZAC PENS The Conklin Nozac (no sac) Pen is distinguished by these revolutionary features: The Cushion Point gives an entirely new idea of writing ease—Patented time-tested filling device that “winds like a watch” provides positive mechanical self-filling, free from rubber sacs, diaphragms, and gadgets—Visible ink supply, with exclusive Word Gauge, shows how many words can be written without refilling—Streamline stylings with Penline or Chevron patterns establish a new conception of beauty in pens—Patented streamline clip, exclusively Conklin . . . These features make the Conklin Nozac Pen the finest, most beautiful precision writing instrument in the world today . . . The Conklin Pen Company, Toledo, Ohio.

“WINDS
LIKE A
WATCH”



DC59 Black
DC59R Red Pearl
DC59G Green Pearl
DC59P Gray Pearl
Chevron design;
7000-word ink capacity. Retail, \$7.50

DC39 Black
DC39R Red Pearl
DC39G Green Pearl
DC39P Gray Pearl
Chevron design;
5000-word ink capacity. Retail, \$5.00

DC83 Black
DC83R Red Pearl
DC83G Green Pearl
DC83P Gray Pearl
Chevron design
pencil. Retail, \$3.50
Matches DC39 and
39 Pens.

DL39R Red Pearl
DL39G Green Pearl
DL39P Gray Pearl
Penline design;
5000-word ink capacity. Retail, \$5.00

DL83R Red Pearl
DL83G Green Pearl
DL83P Gray Pearl
Penline design
pencil. Retail, \$3.50
Matches DL39 Pen.

All Nozac Pens are fitted with the Conklin Cushion point, available in extra fine, fine, medium, coarse, stub medium, stub broad left oblique, two way, and Recorder in extra fine, fine, and medium.



QUICK-FILL AND SACK PENS

The Conklin Quick-fill Pen differs from the Nozac principally in its filling device. The Conklin Quick-fill has a one-stroke vacuum filler. This pen also embodies many other outstanding advantages—visible ink supply—large ink capacity—perfect balance for holding—distinctively modern Penline Stripe styling . . . Conklin Sac Pens are the standard of high quality in rubber sac pens.

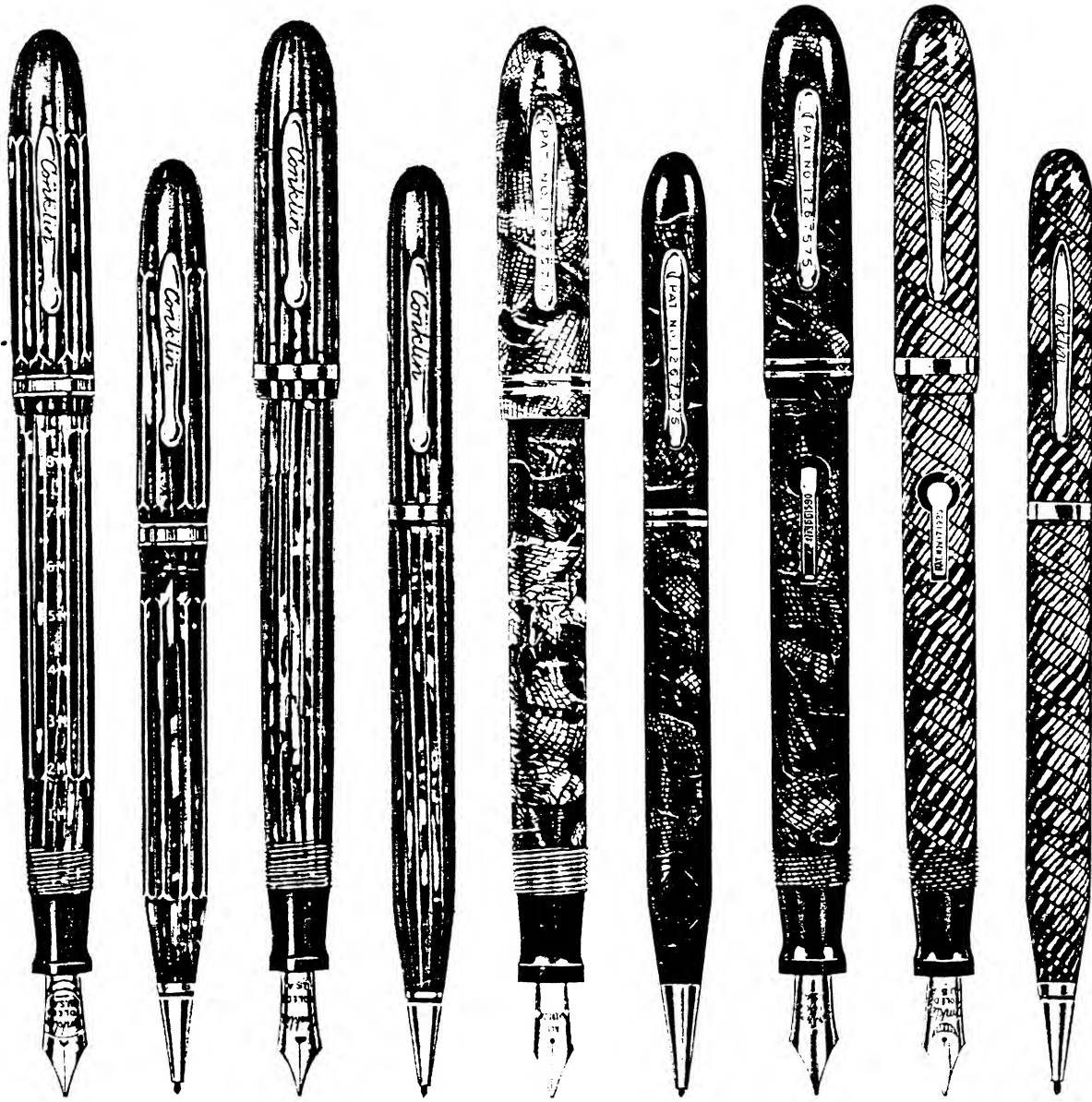

- | | | | | |
|--|---|--|--|--|
| <p>QF49R Red Pearl
 QF49G Green Pearl
 QF49P Gray Pearl
 Quick-fill Pen—Penline design; 8000-word ink capacity; visible ink supply. Retail, \$5.00</p> <p>DL83R Red Pearl
 DL83G Green Pearl
 DL83P Gray Pearl
 Penline design pencil to match QF49 pen. Retail, \$3.50</p> <p>QF39R Red Pearl
 QF39G Green Pearl
 QF39P Gray Pearl
 Same action and style as series QF49. Made shorter especially for women. Retail, \$5.00</p> <p>QFD73SR Red Pearl
 QFD73SG Green Pearl
 QFD73SP Gray Pearl
 Penline design pencil to match QF39 pen. Made shorter especially for women. Retail, \$3.50</p> | <p>QF18R Red Pearl
 QF18G Green Pearl
 QF18P Gray Pearl
 Quick-fill Vacuum Pen—Penline Design. Retail, \$3.50</p> <p>QF73R Red Pearl
 QF73G Green Pearl
 QF73P Gray Pearl
 Penline design pencil to match QF18 pen. Retail, \$2.50</p> <p>QF18SR Red Pearl
 QF18SG Green Pearl
 QF18SP Gray Pearl
 Same style and action as series QF18. Made shorter especially for women. Retail, \$3.50</p> <p>QF73SR Red Pearl
 QF73SG Green Pearl
 QF73SP Gray Pearl
 Same style as series QF73. Made shorter especially for women. Retail, \$2.50</p> | <p>P295RP
 Reptilian Pearl—Gray</p> <p>P295RG
 Reptilian Gold—Green vein</p> <p>P295RF
 Reptilian Foliage—Red vein</p> <p>All American Sac-less Vacuum Pen; one-stroke filler; visible ink supply. Retail, \$2.95</p> | <p>63RP Reptilian Pearl—Gray</p> <p>63RG Reptilian Gold—Green vein</p> <p>63RF Reptilian Foliage—Red vein</p> <p>All American Pencil matches 64R and P295R pens. Retail, \$1.00</p> <p>64RP Reptilian Pearl—Gray</p> <p>64RG Reptilian Gold—Green vein</p> <p>64RF Reptilian Foliage—Red vein</p> <p>All American Sac Pen; lever type filler. Retail, \$1.95</p> | <p>126M Pearl and Gold
 Mosaic Sac Pen; combines shimmering color tones. Retail, \$3.00</p> <p>26C—Same pen as above in Jet Black. Retail, \$2.75</p> <p>Nibs available in Nos. 126M and 26C are extra fine, fine, medium, coarse, and medium stub.</p> <p>73M Pearl and Gold
 Mosaic pencil matches pen 126M. Retail, \$2.00</p> <p>63—Jet Black pen; matches 26C pen. Retail, \$1.00</p> |
|--|---|--|--|--|



Conklin Quick-fill Pens are available with the same nib selection as offered in the Nozac . . . Extra fine, fine, medium, coarse, stub medium,

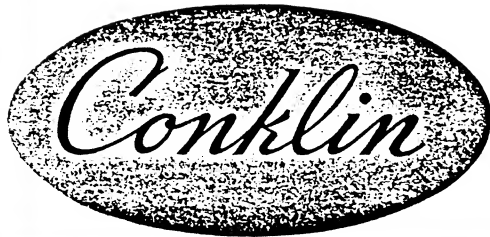

PEN AND PENCIL SETS

Discriminating people ask for Conklin Pen and Pencil Sets. Their distinctiveness and individuality make them the leaders in this field. Conklin Pencils, like the pens, are mechanically perfect.

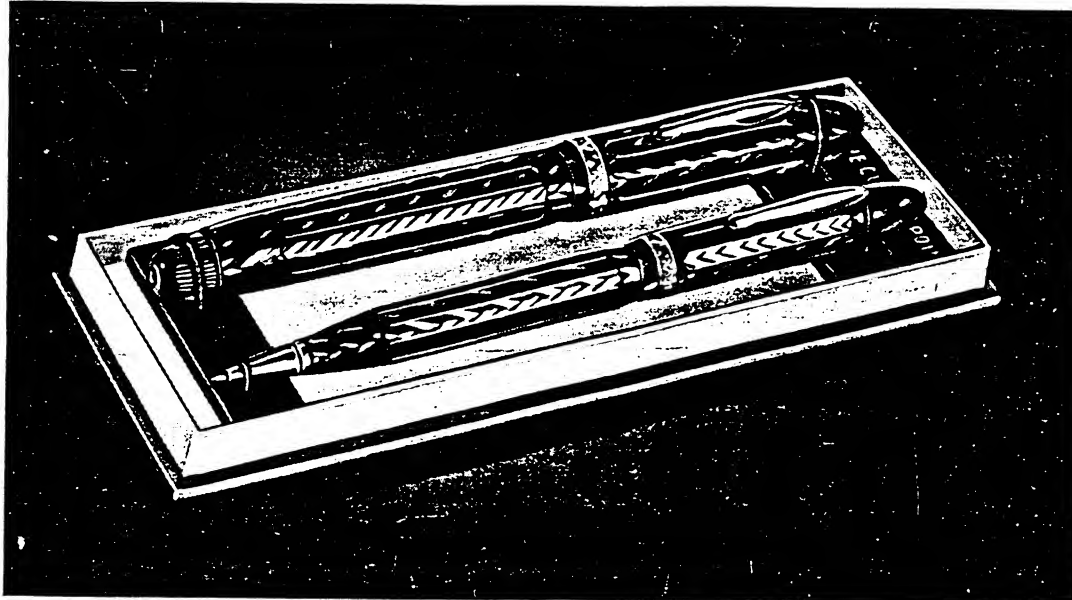

DC8359 Black
DC8359R Red Pearl
DC8359G Green Pearl
DC8359P Gray Pearl
 Nozac Chevron; 7000-word ink capacity. Attractively packaged in beautiful display box. Retail, Set.....\$11.00

DC8339 Black
DC8339R Red Pearl
DC8339G Green Pearl
DC8339P Gray Pearl
 Nozac Chevron; 5000-word ink capacity. Packaged as above. Retail, Set.....\$8.50

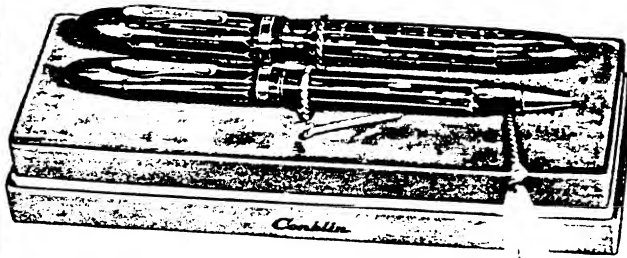

QF8349R Red Pearl
QF8349G Green Pearl
QF8349P Gray Pearl
 Penline Quick-fill; 8000-word ink capacity; visible ink supply. Retail, Set.....\$8.50

QFD7339R Red Pearl
QFD7339G Green Pearl
QFD7339P Gray Pearl
 Ladies' size Penline Quick-fill; same style as above. Retail, Set.....\$8.50

DL8339R Red Pearl
DL8339G Green Pearl
DL8339P Gray Pearl
 Penline Nozac; 5000-word ink capacity. Retail, Set.....\$8.50

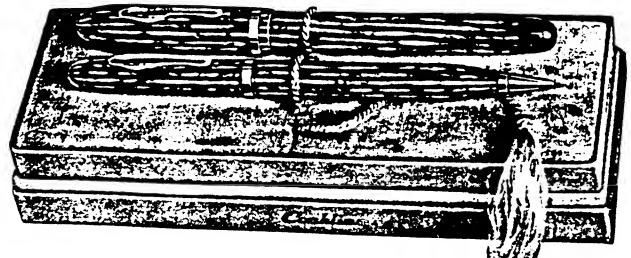

QF7318R Red Pearl
QF7318G Green Pearl
QF7318P Gray Pearl
 Penline Quick-fill—\$6.00 retail value; specially priced when sold as set only. Retail, Set.....\$5.00

QF7318SR Red Pearl
QF7318SG Green Pearl
QF7318SP Gray Pearl
 Ladies' size in same style as above. Same retail value. Retail, Set.....\$5.00
73126M Pearl and Gold
 Mosaic Sac Type; Shimmering tones. Retail, Set.....\$5.00

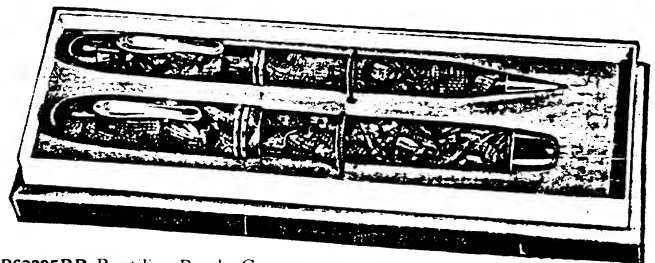

P63295RP Reptilian Pearl—Gray
P63295RG Reptilian Gold—Green Vein
P63295RF Reptilian Foliage—Red Vein
 All American Sac-less; one-stroke vacuum filler; visible ink supply. Retail, Set.....\$3.95

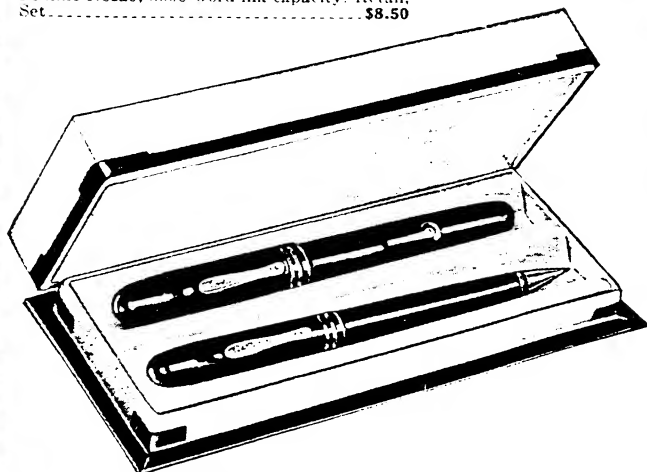

6326 Black

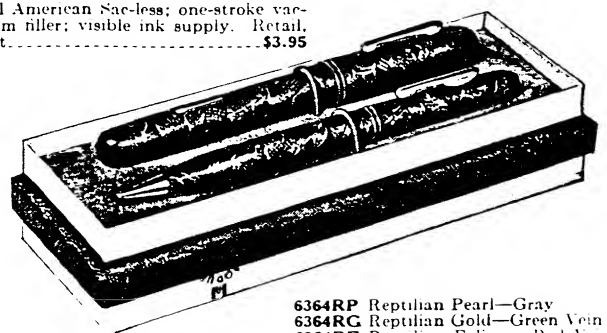

6364RP Reptilian Pearl—Gray
6364RG Reptilian Gold—Green Vein
6364RF Reptilian Foliage—Red Vein

DESK SETS



Among the attractive array of Conklin Desk Sets, there are styles to blend harmoniously with any type of desk. These desk sets combine true artistry of design with maximum writing efficiency. The bases, whether onyx, marble, or metal, are styled and finished to conform in every detail with modern precepts of service and beauty. These sets are available from \$1.95 to \$50.00.



No. 313

Walruswood base: 4 3/4" x 7 3/4". Retail... \$4.95

Equipped with Conklin No. 13 Pen in Green or Black, complete,.....\$6.25

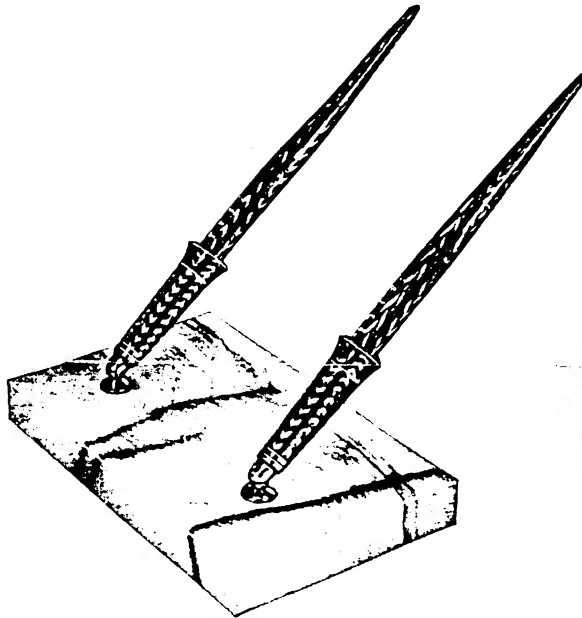

R28 Pedrara Onyx—Natural edges—List Price base only.....\$7.50

MR28 Black and Gold Marble—Natural edges—List Price base only. \$7.50

28 Pedrara Onyx—Polished edges—List Price base only.....\$8.00

M28 Black and Gold Marble—Polished edges. List Price base only.....\$8.00

Series 28—Base size—3 3/4" x 6 1/4"

Chevron Nozac Desk Pens—C19 Black; C19R Red Pearl; C19G Green Pearl; C19P Gray Pearl. Retail, each....\$5.00

Receivers match pens

Any one of four combinations on each base above available. Pens to match, harmonize, or contrast with bases.

Complete Set, Natural Edges. Retail.....\$17.50

Complete Set, Polished Edges. Retail.....\$18.00



13 Pedrara Onyx—Square—Polished edges 3" x 4 1/2".

R13 Pedrara Onyx—Oval—Natural edges 3" x 4 1/2".

M13 Black and Gold Marble—Square—Polished edges 3" x 4 1/2".

MR13 Black and Gold Marble—Oval—Natural edges 3" x 4 1/2".

These bases equipped with any Chevron Nozac Desk Pen.

C19 Black

C19R Red Pearl

C19G Green Pearl

C19P Gray Pearl

Receivers match pens

Retail—Base only, \$5.00; Pen only, \$5.00; Set complete, \$10.00—All Base sizes, 3" x 4 1/2".



Pedrara Onyx—Square—Polished edges 2 1/2" x 3 1/2".

R1 Pedrara Onyx—Oval—Natural edges 2 1/2" x 3 1/2".

A1 Black and Gold Marble—Square—Polished edges 2 1/2" x 3 1/2".

AR1 Black and Gold Marble—Oval—Natural edges 2 1/2" x 3 1/2".

Jet Black Receivers only

Retail—Base only, \$3.50. Equipped with any of the following lever type Desk Pens in black:

All American A12 @ \$1.50 (Set complete, \$5.00)

Conklin 12 @ \$3.50 (Set complete, \$6.50)

Conklin 13 @ \$3.75 (Set complete, \$7.25)

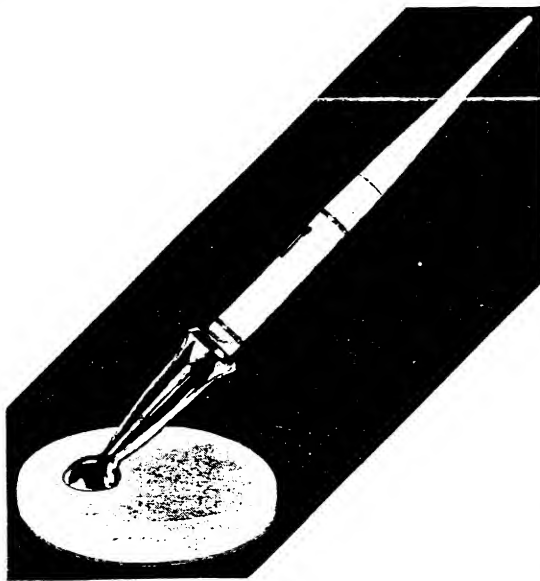

No. AP White

Ladies' Set—Pure white Pedrara Onyx Base; Chromium receiver; white sac pen with white gold trim. Retail, complete set \$5.00



B195

Available in Black, Green, Crystal, and Rose. Set complete with Black All American Desk Pen. Retail \$1.95